

CHEMICAL IMPEDANCE ANALYZER IM3590

Component measuring instruments

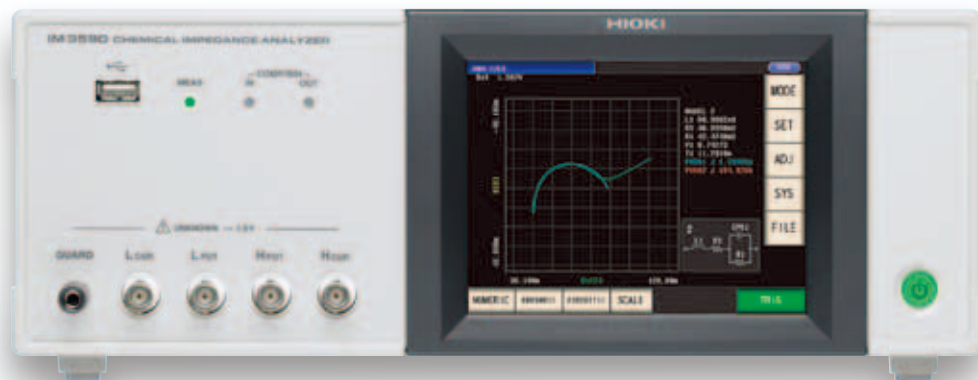

Ideal for Measuring Electrochemical Impedance

Hioki's **Chemical Impedance Analyzer IM3590** is designed to perform impedance (LCR) measurement of electrochemical components and materials. It offers functionality such as Cole-Cole plot generation and equivalent circuit analysis with a broad measurement frequency range of 1 mHz to 200 kHz, measurement speeds as high as 2 ms, and basic accuracy of $\pm 0.05\%$. With the advanced display and analysis functionality required for research and development work and LCR measurement capability for standard electronic components, the instrument provides a single-device solution for a broad range of measurement applications.

Measure Electrochemical Components and Materials, Batteries, and EDLCs*

*Electric double-layer capacitors

Cole-Cole plot

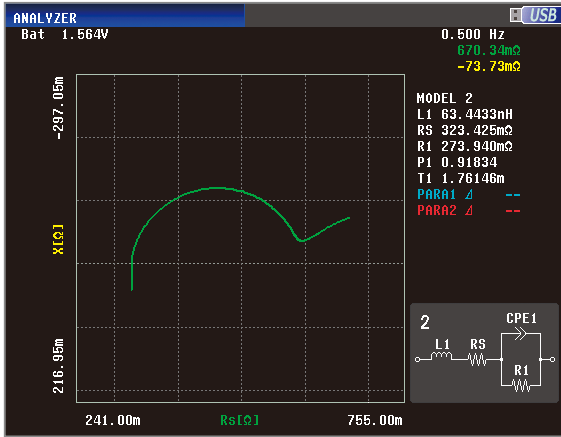

Cole - Cole plot screen (manganese battery)

In measurement of electrochemical components and materials, Cole-Cole plots are used to ascertain electrode, electrolyte ion, and other characteristics. The IM3590 can perform frequency sweep measurement using up to 801 points and display the results as a Cole-Cole plot.

Cole-Cole plot loci and measurement frequency

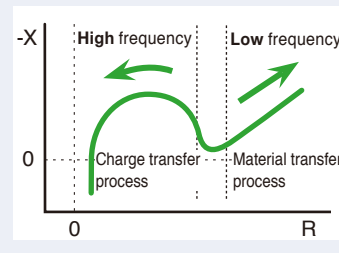

Measurement at low frequencies is necessary in order to measure characteristics such as ion behavior, and the IM3590 can conduct measurements at 1 mHz. The instrument's upper limit frequency is 200 kHz, allowing it to measure solution resistance.

Temperature measurement and time interval measurement

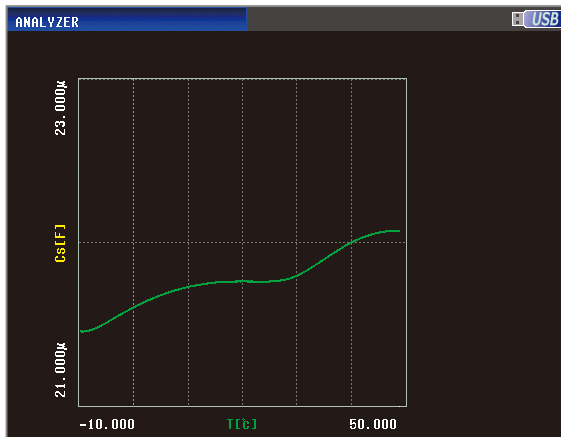

X-Y display screen (Temperature characteristics of multi-layer ceramic capacitor capacitance)

When used in conjunction with an optional temperature probe, the IM3590 can display graphs that include measured temperatures. By assigning temperature to one axis on the X-Y display, it is possible to display a temperature characteristics graph. The instrument can also perform time interval measurement at up to 801 points, and can display graphs illustrating variation over time, including temperature measurement.

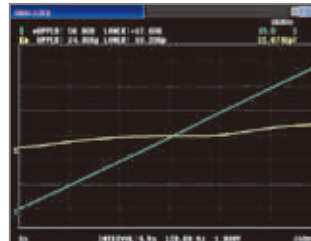

Interval measurement illustrating variation over time (Variation of laminated ceramic capacitor capacitance)

The temperature sensor (Sheath Type Temperature Probe 9478) has a waterproof sheath, allowing it to be directly inserted into solutions.

Sheath material: SUS316
Water-proof property: EN60529:1991, IP67

Advantage

Battery measurement function

The IM3590's battery measurement function simplifies the process of measuring battery impedance characteristics in a no-load state by automatically measuring the battery voltage and superimposing the same voltage from the instrument as DC bias.



Measurement of alkaline batteries

Supported battery specifications

- Internal impedance : 10 mΩ to 10 Ω
- Battery voltage : 5 V max

Measurement time and Z repeatability during low-resistance measurement

(Measurement frequency: 100Hz; Sample: 10mΩ Resistance)

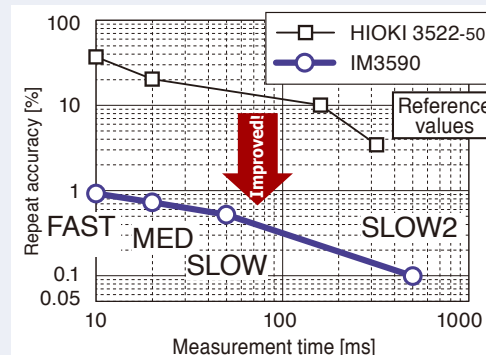

Electrochemical equivalent circuit analysis

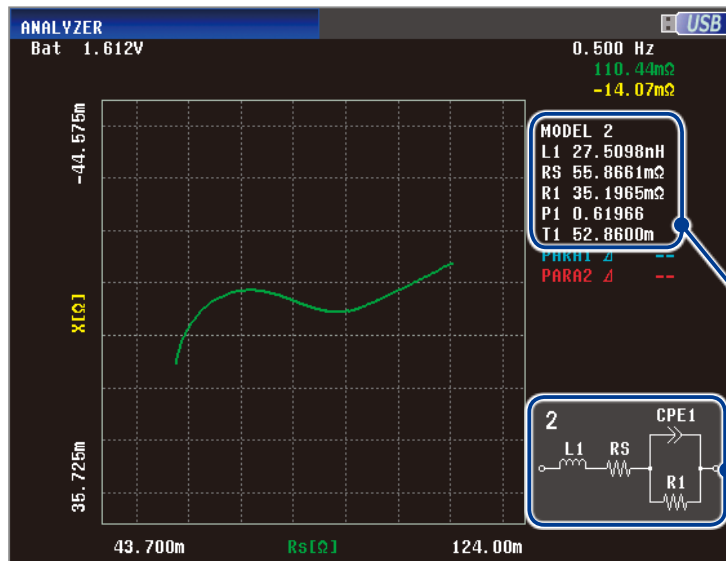

The ability to measure electrochemical components and materials makes possible evaluation by estimating equivalent circuits, facilitating a deeper understanding of reaction, electrode, and electrolyte characteristics. The IM3590 provides electrochemical component and material equivalent circuit models, allowing evaluation of solution resistance, charge transfer resistance, and electric double-layer capacitance.

Equivalent circuit analysis result

Equivalent circuit model

Equivalent circuit analysis screen (alkaline battery)

Equivalent circuit models and measurement parameters

Unipolar models

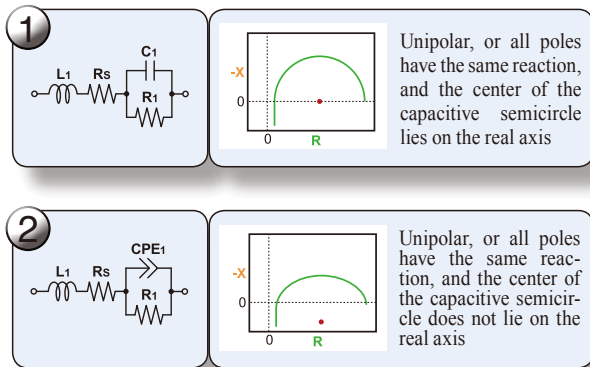

Polar models

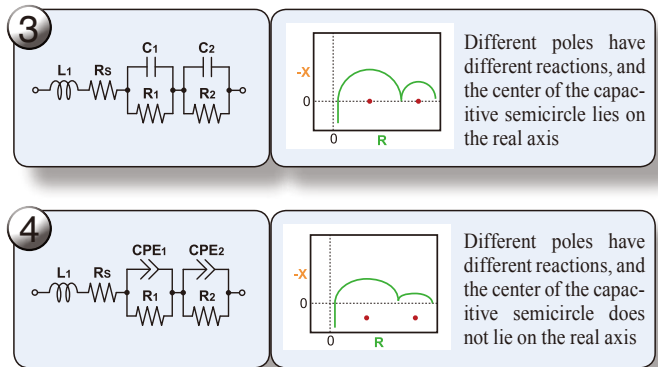

Measurement parameters

R_s (Solution resistance)
 R_1, R_2 (Charge transfer resistance)
 C_1, C_2 (Electric double layer capacitance)
 CPE_1, CPE_2 (Constant Phase Element)
 L_1 (Inductance)

Internal structure of a standard electrochemical cell

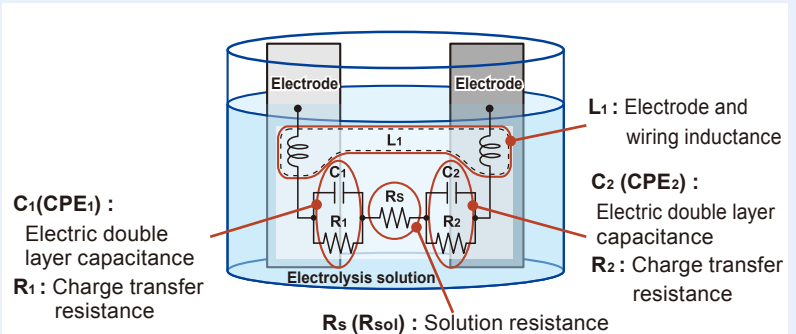

Electronic Components

(LCR Elements and Piezoelectric and Resonant Elements)

Sweep function (Frequency and signal level)

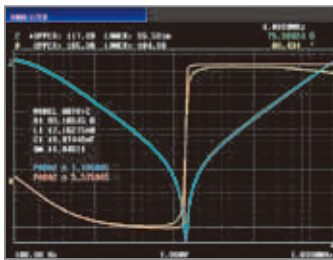

Frequency characteristics and analysis results simulation screen

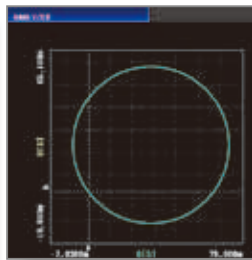

Admittance circle display screen

The IM3590 can perform sweep measurement of the frequency characteristics of standard LCR components such as electronic components and piezoelectric elements (resonant components). The ability to display frequency characteristics, admittance circles, and Cole-Cole plots makes it easy to assess characteristics. The instrument can also perform signal level (V/CV/CC) and DC bias voltage sweep operation.

Equivalent circuit analysis of electronic components

The IM3590 offers five equivalent analysis circuits for circuit components, allowing the instrument to be used to estimate and evaluate standard LCR components such as electronic components and piezoelectric elements (resonant components).

Equivalent Circuit Model and Measurement Items

Three-element model

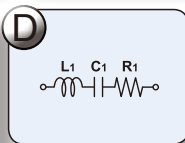
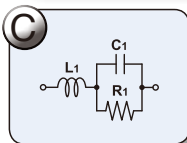
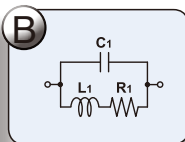
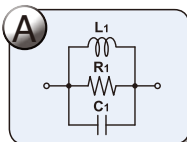

Measurement items

L1 (Inductance)
C1 (Capacitance)
R1 (Resistance)
Qm (Resonance sharpness)

The following measurement items can be captured via PC communication.

f_r (Resonance frequency)
 f_a (Anti-resonance frequency)

Four-element model

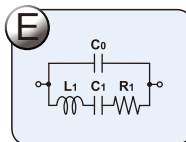

Measurement items

L1 (Inductance)
C1 (Capacitance)
R1 (Resistance)
Co (Parallel capacitance)
Qm (Resonance sharpness or mechanical quality coefficient)

The following measurement items can be captured via PC communication.

f_r (Resonance frequency)
 f_a (Anti-resonance frequency)
 f_s (Series resonance frequency)
 f_p (Parallel resonance frequency)
 f_m (Maximum admittance frequency)
 f_n (Minimum admittance frequency)
 f_1 (Maximum susceptance frequency)
 f_2 (Minimum susceptance frequency)

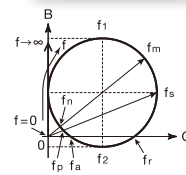

Saving and reading data via front-loading USB port

Measurement results and settings can be saved to a commercially available USB flash drive connected to the front panel.

(The USB port on the front panel is specifically for a USB flash drive. Batch save all measurement results to a USB flash drive after saving them to the internal memory of IM3590. Some USB flash drives may not be supported due to incompatibility issues.)

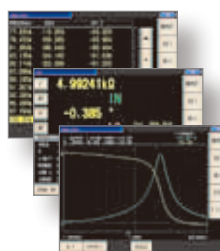

Various measurement results and settings



Save to USB flash drive

Connecting to a PC or PLC via RS-232C, LAN, or GP-IB (select one option) connection

Users can also select an optional RS-232C, LAN, or GP-IB interface if needed. IM3590 functions can be controlled from a PLC or computer, and measurement results can be downloaded. (Certain functions, including instrument power on/off and interface configuration, cannot be controlled remotely.)

Download the LabView driver from the HIOKI website at <http://www.hioki.com>.

External I/O can be used to output measurement complete and judgment result signals and to receive measurement trigger and other signals in order to facilitate control of the instrument.

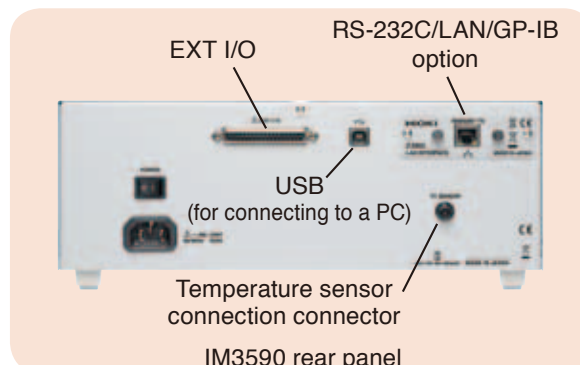

IM3590 rear panel

High-speed, High-precision, Easy-to-use Operation

Basic performance

● Wide setting range for measurement frequency

IM3590 allows DC or a frequency band within the range of 1 mHz to 200 kHz to be set with five-digit resolution (testing at less than 100 Hz has a 1 mHz resolution). This enables the measurement of resonance frequency and measurement and evaluation in a state close to that of actual operating conditions.

The IM3590's frequency range extends from the low frequencies that are required for electrochemical impedance measurement in order to assess phenomena such as ion behavior to high frequencies that allow measurement of solution resistance.

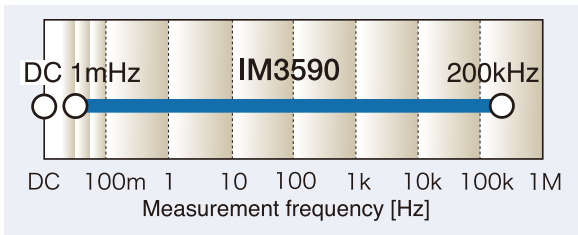

● Wide setting range for measurement voltage and current

In addition to normal open-loop signal generation, this instrument enables measurement considering voltage/current dependence in constant voltage and constant current modes. The signal levels can be set over wide ranges, from 5 mV to 5 V, and from 10 μ A to 50 mA. (The setting range of measurement signal levels differs depending on the frequency and measurement mode.)

● Measurement times as short as 2 ms

The IM3590 can perform measurements in as little as 2 ms using the FAST measurement speed setting with a measurement frequency of 1 kHz.

● Basic accuracy of $\pm 0.05\%$

Thanks to Z basic accuracy of $\pm 0.05\%$, the IM3590 offers a level of accuracy that is ideal for use in applications ranging from component testing to research and development.

● Guaranteed accuracy at measurement cable lengths of up to 4 m

A 4-terminal pair configuration reduces the influence of measurement cables, allowing accuracy to be guaranteed to a length of 4 m and simplifying connections to large samples as well as wiring of automated equipment. (The frequency range over which accuracy is guaranteed varies with the cable length.)

● Measure 18 parameters, including dielectric constant and conductivity

In addition to Z, Y, θ , Rs (ESR), Rp, Rdc (DC resistance), X, G, B, Ls, Lp, Cs, Cp, D (tan σ), Q, and T, the IM3590 can measure the dielectric constant (ϵ) and conductivity (σ). Parameters can be captured by computer as required.

Measurable parameters

Z (impedance[Ω])	Ls (series inductance[H])
Y (admittance[S])	Lp (parallel inductance[H])
θ (phase angle[$^\circ$])	Cs (series capacitance[F])
Rs (Equivalent series resistance = ESR[Ω])	Cp (parallel capacitance[F])
Rp (Parallel resistance[Ω])	Q (Q factor ($Q = 1/D$))
Rdc (DC resistance[Ω])	D (loss coefficient = $\tan \delta$)
X (reluctance[Ω])	T (temperature[$^\circ$ C])
G (conductance[S])	σ (conductivity[S/m])
B (susceptance[S])	ϵ (dielectric constant[F/m])

Functions and Features to Simplify the Operation of LCR Measurements

● Intuitive operation with touch panel

A touch panel display with intuitive operation is inherited from previous models. Furthermore, the incorporation of a color LCD ensures the display is easy to view, and outstanding operability which means you intuitively know what to do helps improve work efficiency.



● Simultaneous display of four parameters (during normal measurement)

The IM3590 can display four parameters simultaneously during normal measurement, making it easy to check among parameters.

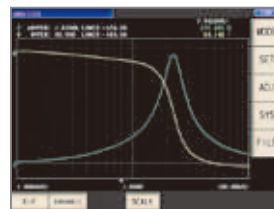

Measurement screen (Analyzer mode)



Measurement parameter input screen



Setting items of basic measurement conditions



Frequency setting (numeric keypad input)

Measurement conditions such as the measurement frequency and measurement signal level can be changed while you monitor the measurement values.

IM3590 measurement accuracy

Conditions

At least 60 minutes after power-on, after performing open and short compensation, with a temperature and humidity range of 23°C ±5°C and relative humidity of 80% or less (non-condensing) (Outside the range of 23°C ±5°C, accuracy can be calculated from 0°C to 40°C by multiplying the basic accuracy by the temperature coefficient G.)

The measurement accuracy is calculated based on the following equation.
Measurement accuracy = Basic accuracy × C × D × E × F × G

[C: Level coefficient] V: Setting value (corresponds to when V mode) [V]

Except Rdc	Rdc
0.005V to 0.999V : 1+0.2/V 1V : 1	2V : 1
1.001V to 5V : 1+2/V	

[D: Measurement speed coefficient]

Except Rdc	Rdc
FAST: 8	FAST: 4
MED: 4	MED: 3
SLOW: 2	SLOW: 2
SLOW2: 1	SLOW2: 1

[E: Measurement cable length coefficient]

Up to 200kHz(no limitations)

0m: 1; 1m: 1.2; 2m: 1.5; 4m: 2

Use a coaxial cable (1.5D-2V) with a characteristic impedance of 50 Ω in a 4-terminal pair configuration.

[F: DC bias coefficient]

DC bias setting OFF : 1

DC bias setting ON : 2

[G: Temperature coefficient] t: Operating temperature

When t is 18°C to 28°C : 1,

When t is 0°C to 18°C or 28°C to 40°C : 1+0.1 × |t-23|

Basic accuracy (Z, θ) calculation expression

Top A: Basic accuracy of Z (± % rdg.)
B is the coefficient for the impedance of the sample

Bottom A: Basic accuracy of θ (± % deg.)
B is the coefficient for the impedance of the sample

A is the accuracy of DC(Rdc) when Rdc (± % rdg.)
B is the coefficient for the resistance of the sample

In the 1 kΩ range and above and 100 Ω range and below, the calculation expression of basic accuracy differs as shown below. For details, refer to the following calculation examples.

1 kΩ range and above:
Accuracy = $A + B \times \left| \frac{10 \times Zx}{Range} - 1 \right|$

100 Ω range and below:
Accuracy = $A + B \times \left| \frac{10 \times Zx}{Range} - 1 \right|$

Zx is the actual impedance measurement value (Z) of the sample.

When temperature compensation is performed during Rdc measurement, add the following value to the calculation expression of basic accuracy.

$$\frac{-100 \alpha_{10} \Delta t}{1 + \alpha_{10} \times (t + \Delta t - t_0)} \quad [\%]$$

t: Reference temperature [°C]
t: Current ambient temperature [°C]
Δt: Temperature measurement accuracy
α_{t0}: Temperature coefficient for t₀ [1/°C]

Basic accuracy

Guaranteed accuracy period: 1 year

When all coefficients by which the basic accuracy is multiplied (signal level of 1 V or Rdc measurement, measurement speed of SLOW2, measurement cable length of 0 m [when using Test Fixture 9262 or similar], DC bias setting of OFF, and operating temperature of 23°C ±5°C) are 1, the basic accuracy is the measurement accuracy.

Range	Guaranteed accuracy range	DC(Rdc)	0.001Hz to 99.999Hz	100.00Hz to 999.99Hz	1.0000kHz to 10.000kHz	10.001kHz to 100.00kHz	100.01kHz to 200.00kHz
100MΩ	8MΩ to 200MΩ	A=1 B=1	A=6 B=5 A=5 B=3	A=3 B=2 A=2 B=2	A=3 B=2 A=2 B=2		
10MΩ	800kΩ to 100MΩ	A=0.5 B=0.3	A=0.8 B=1 A=0.8 B=0.5	A=0.5 B=0.3 A=0.4 B=0.2	A=0.5 B=0.3 A=0.4 B=0.2	A=3 B=2 A=2 B=2	
1MΩ	80kΩ to 10MΩ	A=0.2 B=0.1	A=0.4 B=0.08 A=0.3 B=0.08	A=0.3 B=0.05 A=0.2 B=0.02	A=0.3 B=0.05 A=0.2 B=0.02	A=0.7 B=0.08 A=1.3 B=0.08	A=1 B=0.5 A=3 B=0.5
100kΩ	8kΩ to 1MΩ	A=0.1 B=0.01	A=0.3 B=0.03 A=0.3 B=0.02	A=0.2 B=0.03 A=0.1 B=0.02	A=0.15 B=0.02 A=0.1 B=0.015	A=0.25 B=0.04 A=0.4 B=0.02	A=0.4 B=0.3 A=1.2 B=0.3
10kΩ	800Ω to 100kΩ	A=0.1 B=0.01	A=0.3 B=0.025 A=0.3 B=0.02	A=0.2 B=0.025 A=0.1 B=0.02	A=0.05 B=0.02 A=0.03 B=0.02	A=0.2 B=0.025 A=0.4 B=0.02	A=0.3 B=0.03 A=0.6 B=0.05
1kΩ	80Ω to 10kΩ	A=0.1 B=0.01	A=0.3 B=0.02 A=0.2 B=0.02	A=0.2 B=0.02 A=0.1 B=0.02	A=0.15 B=0.02 A=0.08 B=0.02	A=0.2 B=0.02 A=0.4 B=0.02	A=0.3 B=0.02 A=0.6 B=0.02
100Ω	8Ω to 100Ω	A=0.1 B=0.02	A=0.4 B=0.02 A=0.2 B=0.01	A=0.3 B=0.02 A=0.15 B=0.01	A=0.15 B=0.02 A=0.1 B=0.01	A=0.2 B=0.02 A=0.4 B=0.02	A=0.3 B=0.03 A=0.6 B=0.02
10Ω	800mΩ to 10Ω	A=0.2 B=0.15	A=0.5 B=0.2 A=0.3 B=0.1	A=0.4 B=0.05 A=0.3 B=0.03	A=0.3 B=0.05 A=0.15 B=0.03	A=0.3 B=0.05 A=0.75 B=0.05	A=0.4 B=0.2 A=1.5 B=0.1
1Ω	80mΩ to 1Ω	A=0.3 B=0.3	A=2 B=1 A=1 B=0.6	A=0.6 B=0.3 A=0.5 B=0.2	A=0.4 B=0.3 A=0.25 B=0.2	A=0.4 B=0.3 A=1 B=0.2	A=1 B=1 A=2 B=0.5
100mΩ	10mΩ to 100mΩ	A=3 B=3	A=10 B=10 A=6 B=6	A=3 B=3 A=2 B=2	A=3 B=2 A=2 B=1.5	A=2 B=2 A=2 B=1.5	A=4 B=3 A=3 B=4

Method for determining basic accuracy

- Calculate the basic accuracy from the sample impedance, measurement range, and measurement frequency and the corresponding basic accuracy A and coefficient B from the table above.
- The calculation expression to use differs for each of the 1 kΩ range and above and 100 Ω range and below.
- For C and L, obtain basic accuracy A and coefficient B by determining the measurement range from the actual measurement value of impedance or the approximate impedance value calculated with the following expression.

$$Zx (\Omega) \approx \omega L (H) \quad (\theta \approx 90^\circ)$$

$$\approx \frac{1}{\omega C (F)} \quad (\theta \approx -90^\circ)$$

$$\approx R (\Omega) \quad (\theta \approx 0^\circ) \quad (\omega: 2 \times \pi \times \text{Measurement frequency [Hz]})$$

Calculation example

Impedance Zx of sample: 500 Ω (actual measurement value)

Measurement conditions: When frequency 10 kHz and range 1 kΩ

Insert coefficient A = 0.15 and coefficient B = 0.02 for the Z basic accuracy from the table above into the expression.

$$Z \text{ basic accuracy} = 0.15 + 0.02 \times \left| \frac{10 \times 500}{10^3} - 1 \right| = 0.23 (\pm \% \text{rdg.})$$

Similarly, insert coefficient A = 0.08 and coefficient B = 0.02 for the θ basic accuracy, as follows:

$$\theta \text{ basic accuracy} = 0.08 + 0.002 \times \left| \frac{10 \times 500}{10^3} - 1 \right| = 0.16 (\pm \% \text{deg.})$$

IM3590 measurement accuracy

Guaranteed accuracy range (measurement signal level)

The guaranteed accuracy range differs depending on the measurement frequency, measurement signal level, and measurement range.

Range	DC	0.001Hz to 99.999Hz	100.00Hz to 999.99Hz	1.0000kHz to 10.000kHz	10.001kHz to 100.00kHz	100.01kHz to 200.00kHz	
100M Ω	2 V	0.101 V to 5 V					
10M Ω		0.101 V to 5 V					
1M Ω		0.050 V to 5 V		0.101 V to 5 V	0.501 V to 5 V		
100k Ω		0.005 V to 5 V			0.050 V to 5 V	0.101 V to 5 V	
10k Ω , 1k Ω , 100 Ω		0.050 V to 5 V					
10 Ω		0.101 V to 5 V (Guaranteed accuracy of 0.501 V to 5 V when DC bias.)					
1 Ω		0.501 V to 5 V (Guaranteed accuracy of 1 V to 5 V when DC bias.)					
100m Ω		0.501 V to 5 V (Guaranteed accuracy of 1 V to 5 V when DC bias.)					

The above voltages are the voltage setting values correspond to when in V mode.

In the 10 M Ω to 1 k Ω range, the guaranteed accuracy range is as follows when measured values (impedance values) exceed the range.

Range	DC	0.001Hz to 99.999Hz	100.00Hz to 999.99Hz	1.0000kHz to 10.000kHz	10.001kHz to 100.00kHz	100.01kHz to 200.00kHz	
10M Ω	2 V	0.101 V to 5 V					
1M Ω		0.101 V to 5 V					
100k Ω		0.050 V to 5 V		0.101 V to 5 V	0.501 V to 5 V		
10k Ω		0.005 V to 5 V			0.050 V to 5 V	0.101 V to 5 V	
1k Ω		0.050 V to 5 V					

The above voltages are the voltage setting values correspond to when in V mode.

Specifications Product warranty: 1 year

Measurement modes	LCR mode: Measurement with single condition Continuous measurement mode: Measures under saved conditions continuously LCR mode (maximum of 60 sets) Analyzer mode (maximum of 2 sets) Analyzer mode: Measurement frequency or measurement level sweep operation, temperature characteristics, equivalent circuit analysis (Measurement points: 2 to 801, Measurement method: normal sweep or segment sweep, Display: List display or graph display)	DC bias measurement	Normal mode: -5.00 V to 5.00 VDC (10 mV steps) Low impedance high accuracy mode: -2.50 V to 2.50 V (10 mV steps)
Measurement parameters	Z, Y, θ , Rs(ESR), Rp, Rdc(DC resistance), X, G, B, Cs, Cp, Ls, Lp, D(tand), Q, T, σ , ϵ	DCR (DC resistance) measurement	Measurement signal level: Fixed to 2 V Temperature compensation function: Converted reference temperature is displayed Reference temperature setting range: -10°C to 99.9°C Temperature coefficient setting range: -99,999ppm/°C to 99,999ppm/°C
Measurement range	100 m Ω to 100 M Ω , 10 ranges (All parameters are determined according to Z) Guaranteed accuracy range: 10 m Ω to 200 M Ω	Temperature measurement function	Temperature Probe: Sheath Type Temperature Probe 9478 (option) Measurement range: -10°C to 99.9°C Sampling cycle: Around 640ms
Display range	Z, Y, Rs, Rp, Rdc, X, G, B, Ls, Lp, Cs, Cp, σ , ϵ : $\pm(0.00000$ [unit] to 9.999999 [unit]) Absolute value display for Z and Y only θ : $\pm(0.000^\circ$ to $999.999^\circ)$ D: $\pm(0.00000$ to $9.99999)$ Q: $\pm(0.00$ to $9999.99)$ Δ %: $\pm(0.000\%$ to $999.999\%)$ T: -10.0 °C to 99.9 °C	Comparator	LCR mode: Hi/IN/Lo for 2 parameters
Basic accuracy	Z: $\pm 0.05\%$ rdg. θ : $\pm 0.03^\circ$	BIN measurement	10 classifications and out of range for 2 parameters
Measurement frequency	1 mHz to 200 kHz (1 mHz to 10 Hz steps)	Compensation	Open/short/load/correlation compensation Cable length: 0, 1, 2 and 4 m
Measurement signal level	Normal mode: V mode/CV mode: 5 mV to 5 Vrms, 1 mVrms steps CC mode: 10 μ A to 50 mArms, 10 μ Arms steps Low impedance high accuracy mode: V mode/CV mode: 5 mV to 2.5 Vrms, 1 mVrms steps CC mode: 10 μ A to 100 mArms, 10 μ Arms steps With battery measurement function ON: V mode: 101 mV to 1.25 Vrms, 1 mVrms steps CV mode: 5 mV to 1.25 Vrms, 1 mVrms steps CC mode: 2 mA to 50 mArms, 10 μ Arms steps	Residual charge protection function	$V = \sqrt{10/C}$ (C: Capacitance [F] of test sample, V = max. 400 V)
Output impedance	Normal mode: 100 Ω Low impedance high accuracy mode: 25 Ω	Trigger synchronous output function	Applies a measurement signal during analog measurement only
Display	5.7-inch color TFT, display can be set to ON/OFF	Averaging	1 to 256
No. of display digits setting	The number of display digits can be set from 3 to 6 (initial value: 6 digits)	Panel loading/saving	LCR mode: 60; Analyzer mode: 2; Compensation value: 128
Measurement time	2 ms (1 kHz, FAST, display OFF, representative value)	Memory function	Stores 32,000 data items to the memory of the instrument
Measurement speed	FAST/MED/SLOW/SLOW2	Interfaces	EXT I/O (handler), USB (Hi-Speed), USB flash drive Option: RS-232C, GP-IB, LAN (10BASE-T/100BASE-TX), Only 1 Optional Interface can be installed at any one time
		Operating temperature and humidity ranges	0 °C (32 °F) to 40°C (104 °F), 80% RH or less, no condensation
		Storage temperature and humidity ranges	-10°C (14 °F) to 55°C (131 °F), 80% RH or less, no condensation
		Power supply	100 to 240 V AC, 50/60 Hz, 50 VA max.
		Dimensions and mass	Approx. 330 W x 119 H x 168 D mm, approx. 3.1 kg Approx. 12.99" W x 4.69" H x 6.61" D, approx. 109.3 oz.
		Accessories	Power Cord x 1, Instruction Manual x 1, CD-R (Communication Instruction Manual and Sample Software [Communications Control, Accuracy Calculation, and Screen Capture Functionality]) x 1
		Applicable standards	EMC: EN61326-1, EN61000-3-2, EN61000-3-3 Safety standard: EN61010

Options

Four-Terminal Probe for Electrochemical Measurement

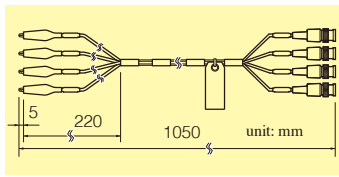
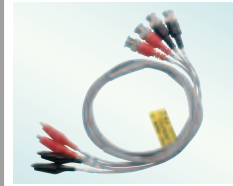

FOUR-TERMINAL PROBE 9500-10

Cable length 1 m (3.28 ft), DC to 200 kHz, impedance characteristics of 50 Ω, 4-terminal pair configuration, measurable conductor diameter: $\phi 0.3$ mm (0.01 in) to 2 mm (0.08 in)

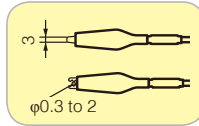

DC Bias Unit



DC BIAS VOLTAGE UNIT 9268-10

Direct connection type, 40 Hz to 8 MHz, maximum applied voltage of DC ± 40 V.



DC BIAS CURRENT UNIT 9269-10

Direct connection type, 40 Hz to 2 MHz, maximum applied current of DC 2 A (maximum applied voltage of DC ± 40 V).

When using the 9268-10 or 9269-10, external constant-voltage and constant-current sources are required.

Probes and Test Fixtures for Lead Components

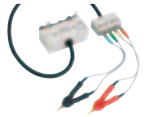

FOUR-TERMINAL PROBE L2000

Cable length 1 m (3.28 ft), DC to 8 MHz, impedance characteristics of 50 Ω, 4-terminal pair configuration, measurable conductor diameter: $\phi 0.3$ mm (0.01 in) to 5 mm (0.20 in)

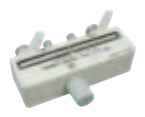

TEST FIXTURE 9262

Direct connection type, DC to 8 MHz, measurable conductor diameter: $\phi 0.3$ mm (0.01 in) to 2 mm (0.08 in)

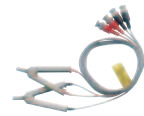

FOUR-TERMINAL PROBE 9140-10

Cable length 1 m (3.28 ft), DC to 200 kHz, impedance characteristics of 50 Ω, 4-terminal pair configuration, measurable conductor diameter: $\phi 0.3$ mm (0.01 in) to 5 mm (0.20 in)

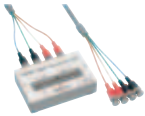

TEST FIXTURE 9261-10

Cable length 1 m (3.28 ft), DC to 8 MHz, impedance characteristics of 50 Ω, 4-terminal pair configuration, measurable conductor diameter: $\phi 0.3$ mm (0.01 in) to 1.5 mm (0.06 in)



Test Fixtures for SMD



SMD TEST FIXTURE 9263

Direct connection type, DC to 8 MHz, Test sample dimensions: 1 mm (0.04 in) to 10 mm (0.39 in)



SMD TEST FIXTURE 9677

Direct connection type, Electrodes on side for SMD, DC to 120 MHz, Test sample dimensions: 3.5 mm ± 0.5 mm (0.14 in ± 0.02 in)



SMD TEST FIXTURE 9699

Direct connection type, Electrodes on bottom for SMD, DC to 120 MHz, Test sample dimensions: 1.0 mm (0.04 in) to 4.0 mm (0.16 in) wide, maximum 1.5 mm (0.06 in) high



SMD TEST FIXTURE IM9100

Compatible with 0402-, 0603-, and 1005-size SMDs, 4-terminal electrode design, capable of high-precision measurement



PINCHER PROBE L2001



*Ships standard with one set of IM9901

Cable length 730 mm (2.40 ft), DC to 8 MHz, characteristic impedance of 50 Ω, 4-terminal pair design, 2-terminal electrode, tip electrode spacing of 0.3 to approx. 6 mm (0.01 to approx. 0.24 in)

Options for L2001

Replaceable contact tips



CONTACT TIPS IM9901

Compatible chip sizes: 1608 to 5750 (JIS)



CONTACT TIPS IM9902

Compatible chip sizes: 0603 to 5750 (JIS)

CHEMICAL IMPEDANCE ANALYZER IM3590

(Standard accessories: Power Cord, Instruction Manual, CD-R (Communication Instruction Manual and Sample Software [Communications Control, Accuracy Calculation, and Screen Capture Functionality]))

Test fixtures are not supplied with the unit.
Select an optional test fixture or probe when ordering.
Probes are constructed with a coaxial cable with 50Ω impedance characteristics.

TEMPERATURE PROBE

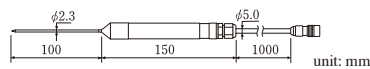

SHEATH TYPE TEMPERATURE PROBE 9478

Pt100, tip $\phi 2.3$ mm (0.09 in), cord length 1 m (3.28 ft), water-proof structure, water-proof property: EN60529:1991, IP67

INTERFACE UNIT (Only 1 can be installed at any one time)



GP-IB INTERFACE Z3000



RS-232C INTERFACE Z3001*



LAN INTERFACE Z3002

*RS-232C cable

For RS-232C cable, a crossover cable for interconnection can be used. The RS-232C cable 9637 (9-pin to 9-pin, crossed cable) cannot be used for applications involving the flow control of hardware.

INTERFACE CABLE



GP-IB CONNECTION CABLE 9151-02

2 m (6.56 ft)

Note: Company names and Product names appearing in this catalog are trademarks or registered trademarks of various companies.

HIOKI

HIOKI E. E. CORPORATION

HEADQUARTERS

81 Koizumi, Ueda, Nagano, 386-1192, Japan
TEL +81-268-28-0562 FAX +81-268-28-0568
http://www.hioki.com / E-mail: os-com@hioki.co.jp

HIOKI USA CORPORATION

TEL +1-609-409-9109 FAX +1-609-409-9108
http://www.hiokiusa.com / E-mail: hioki@hiokiusa.com

HIOKI (Shanghai) SALES & TRADING CO., LTD.
TEL +86-21-63910090 FAX +86-21-63910360
http://www.hioki.cn / E-mail: info@hioki.com.cn

HIOKI INDIA PRIVATE LIMITED
TEL +91-124-6590210 FAX +91-124-6460113
E-mail: hioki@hioki.in

HIOKI SINGAPORE PTE. LTD.
TEL +65-6634-7677 FAX +65-6634-7477
E-mail: info-sg@hioki.com.sg

HIOKI KOREA CO., LTD.
TEL +82-42-936-1281 FAX +82-42-936-1284
E-mail: info-kr@hioki.co.jp

DISTRIBUTED BY

instrumentos
de medida

Septiembre, 31 - 28022 Madrid
Tel. 913000191 - Fax. 913885433

www.idm-instrumentos.es - idm@idm-instrumentos.es